



Agroplastic

GRUPO SANZ

KITS Y ACCESORIOS PARA **MOSQUITERA**

*KITS AND ACCESSORIES FOR **INSECT SCREEN***





Agroplastic

GRUPO SANZ

AGROPLASTIC nace con la misión de ofrecer productos inyectados en plástico con unos altos estándares de calidad, que nos han servido para fidelizar a nuestros clientes en sectores muy exigentes, como industria automovilística, productos agrícolas y material de construcción, entre otros.

En la actualidad estamos especializados en el diseño y fabricación de piezas plásticas para el sector de la mosquitera.

Nuestro sistema de producción LEAN permite la optimización de toda la cadena productiva obteniendo una mayor competitividad en el mercado.

Gracias a nuestro proceso integrado (diseño, matricería, inyección y montaje) ofrecemos una ventaja competitiva a nuestros clientes, única en el mercado.

AGROPLASTIC was created with the mission of offering plastic injection moulded products with high standards of quality, which have allowed us to secure the loyalty of our clients in highly demanding sectors such as the automotive, farming products and construction materials industries, among others.

Our Lean Production system ensures the optimisation of the entire production chain, enhancing the competitiveness of our products on the market.

Through our integrated process (design, tooling, injection and assembly), we offer to our clients, a competitive advantage unique in the market.

VALOR AÑADIDO

Nuestra planta de producción está formada por 16 inyectoras que van desde 60 hasta 650 toneladas, pudiendo realizar piezas de plástico que van desde 10 gramos hasta 2,8 kilogramos.

ADDED VALUE

Our production plant is equipped with 16 injection moulding machines, from 60 to 650 tonnes, capable of making plastic parts ranging from 10 g to 2.8 kg.

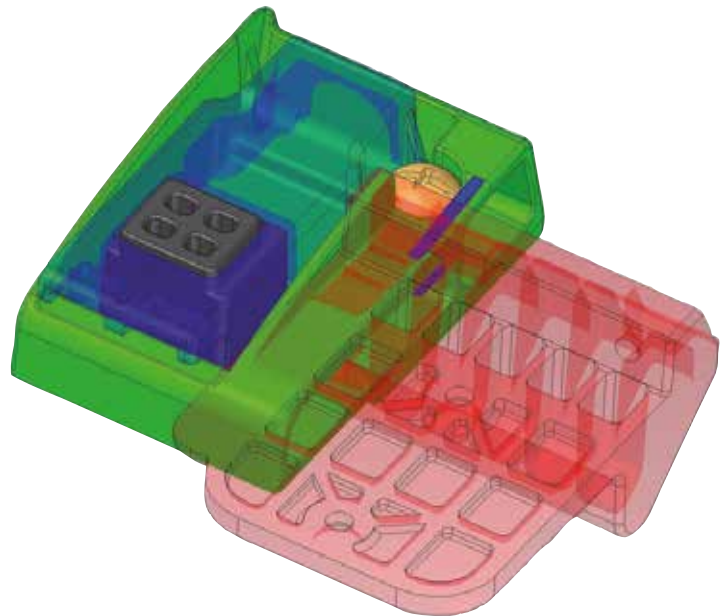

MOSQUITERA ENROLLABLE

ROLLER INSECT SCREEN

colores / colors

caja / pack



50 u.

Kit básico / Basic kit

Incluye:

Testeros izq y dch para cajón (46, 42, 35, 33)

Muelle con funda y pivote

2 Casquillos

2 Tapón terminal

2 Manetas

1 Tirador cordón

1 Juego de frenos

Bolsa de tacos y tornillos

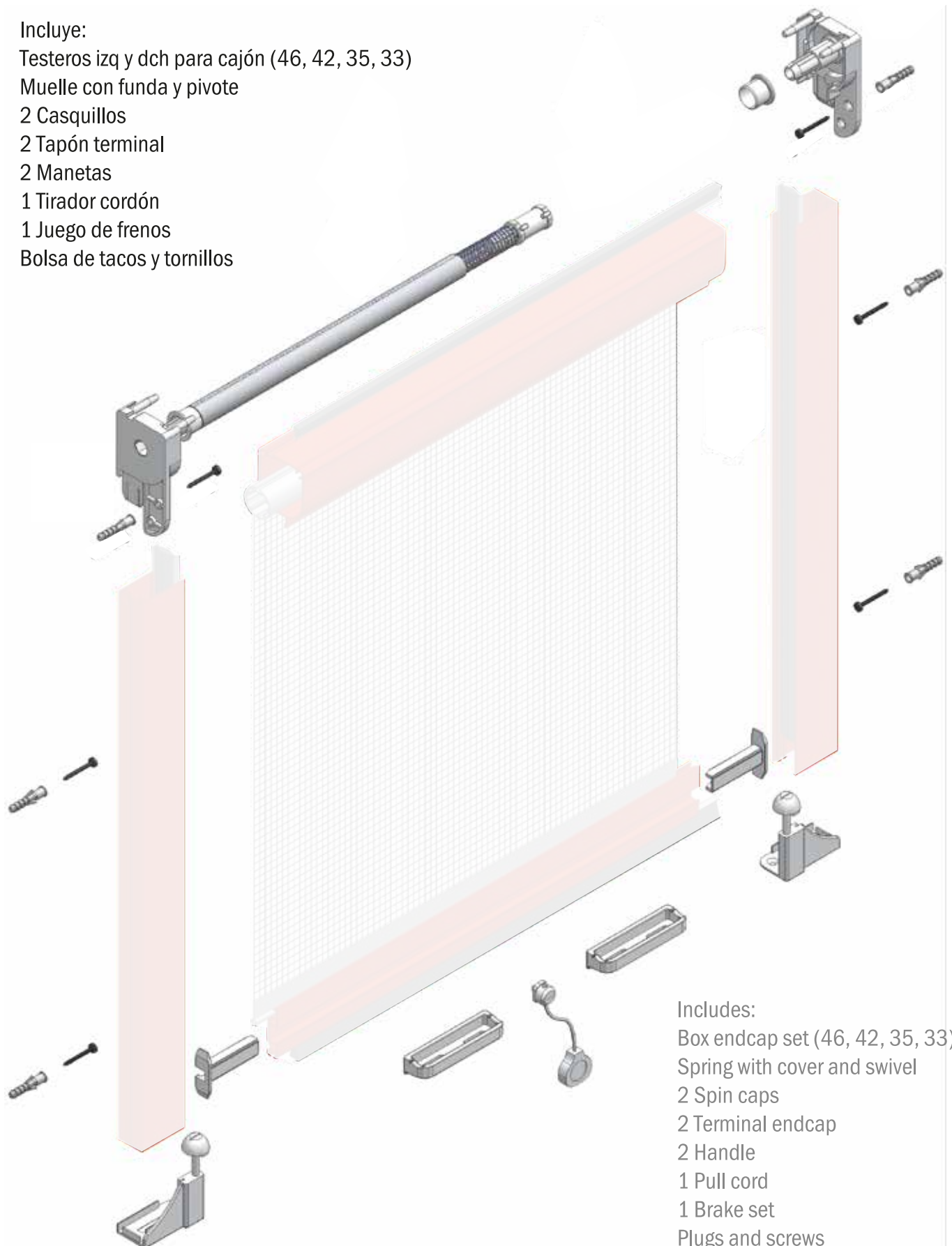

Includes:

Box endcap set (46, 42, 35, 33)

Spring with cover and swivel

2 Spin caps

2 Terminal endcap

2 Handle

1 Pull cord

1 Brake set

Plugs and screws

MOSQUITERA ENROLLABLE

ROLLER INSECT SCREEN

colores / colors



Cabezales compatibles / Compatible heads

CAJÓN BOX 46

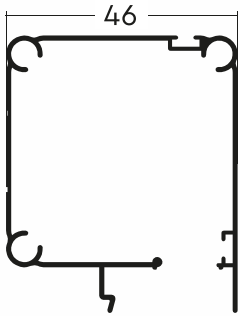

C46

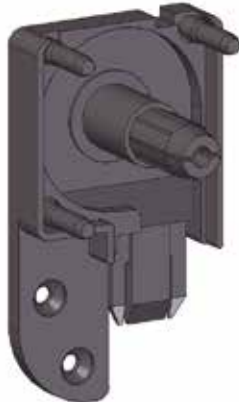

CAJÓN BOX P42



P44

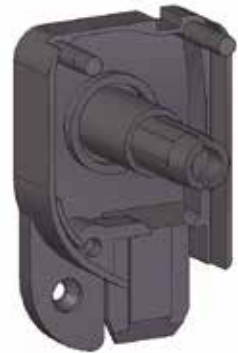

CAJÓN BOX P42

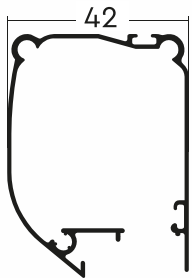

P42



CAJÓN BOX P42



AUP42

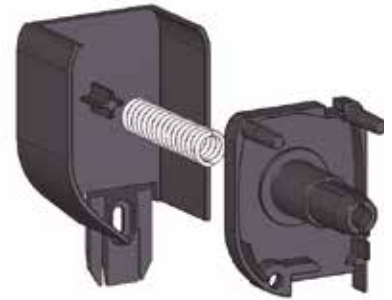

CAJÓN BOX R42

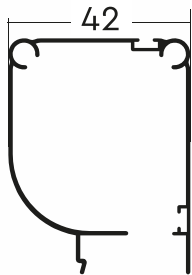

R42

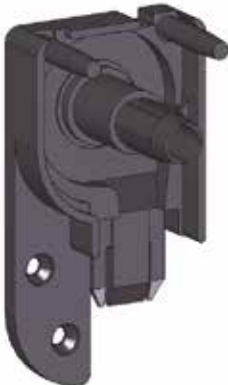

CAJÓN BOX R42

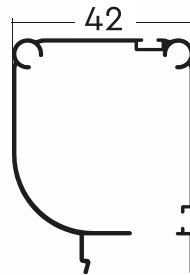

TR42



CAJÓN BOX R33

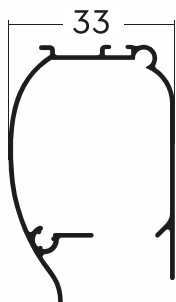

R33

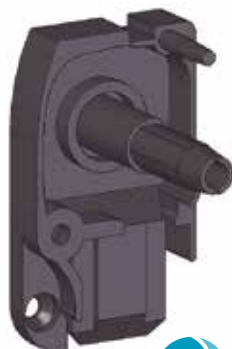

CAJÓN BOX TR35

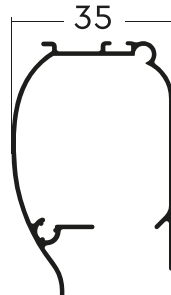

TR35

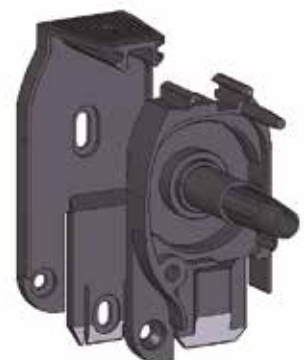

MOSQUITERA ENROLLABLE

ROLLER INSECT SCREEN

colores / colors



Kit sistema de fijación frontal / Front fixing system kit

Incluye:

Kit básico (ver pág. 03)

2 Soportes frontales

1 Set freno invisible

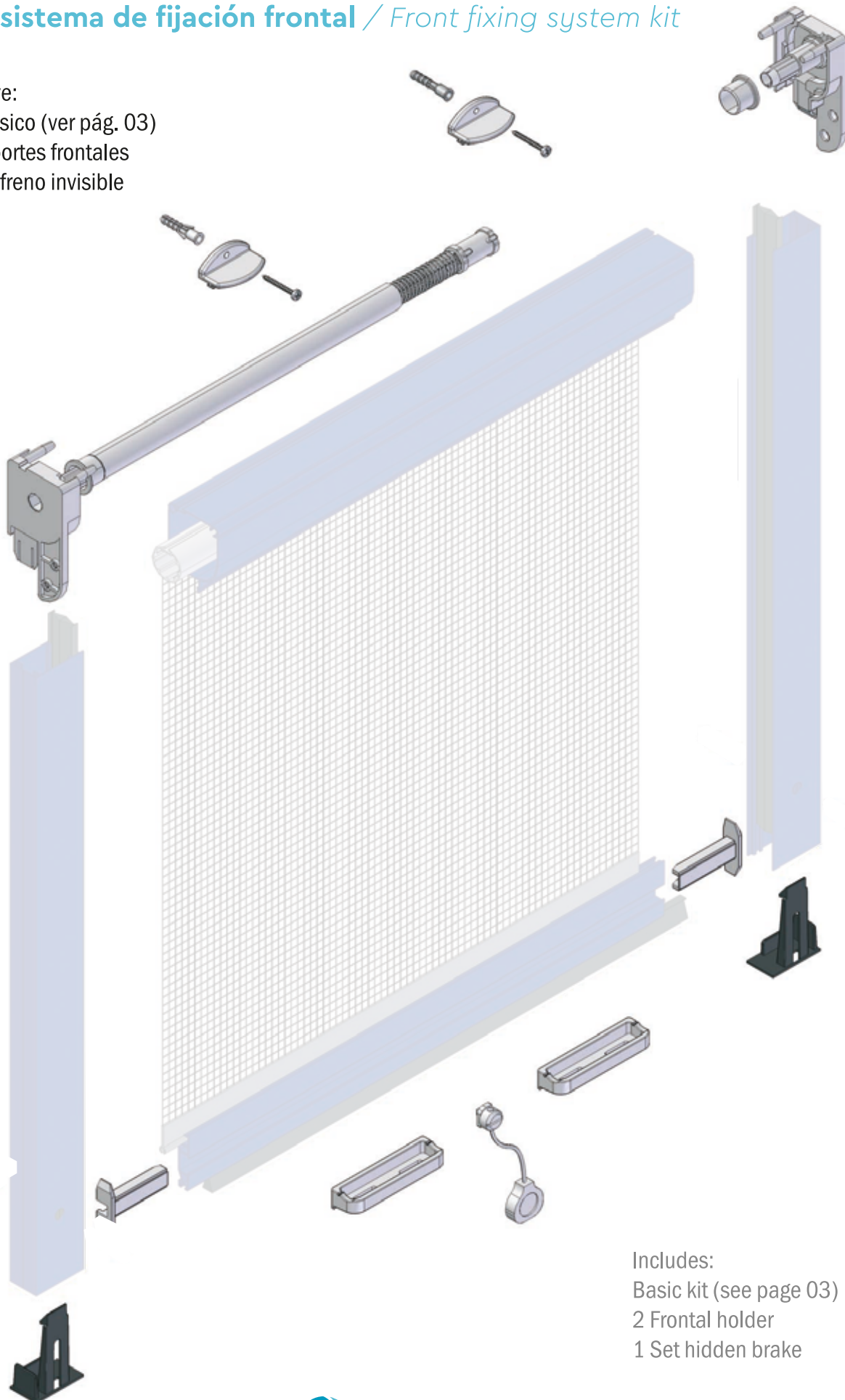

Includes:

Basic kit (see page 03)

2 Frontal holder

1 Set hidden brake

MOSQUITERA ENROLLABLE

ROLLER INSECT SCREEN

colores / colors



Cabezales compatibles fijación frontal / Compatible heads front fixing syst.

CAJÓN
BOX 46

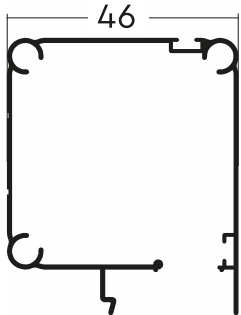

C46

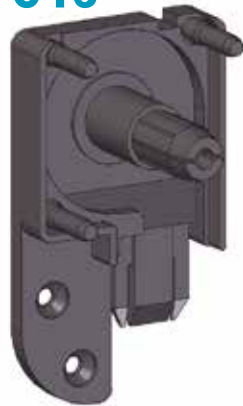

CAJÓN
BOX P42

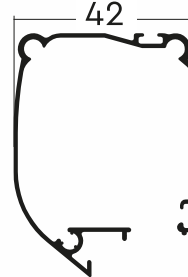

P44

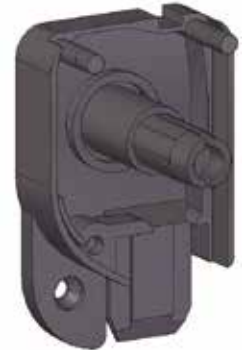

CAJÓN
BOX P42

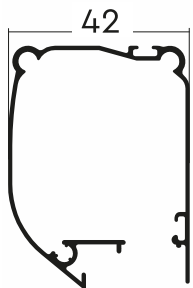

P42



CAJÓN
BOX R42

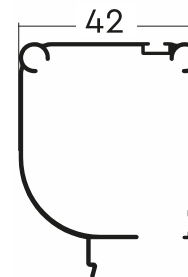

R42

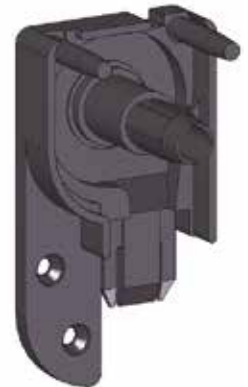

CAJÓN
BOX 33

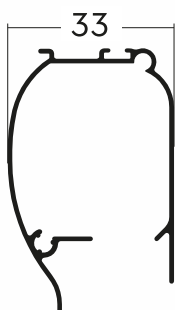

R33

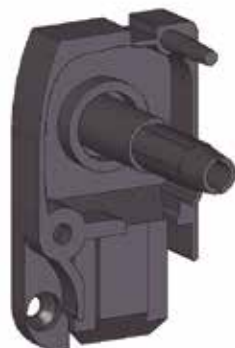

FRENO OCULTO
HIDDEN BRAKE



SOPORTE FRONTAL
FRONTAL HOLDER

MOSQUITERA ENROLLABLE

ROLLER INSECT SCREEN

Aup universal para cajones 42 / *Aup universal for box 42*

Auto sujeción para la instalación del cabezal de la mosquitera enrollable.

Self-clamping for the installation of the roller insect screen head.



NOVEDADES
NEWS
¡Ahorre tiempo en la
instalación de la mosquitera!

Save time on the installation
of the insect screen!

MOSQUITERA ENROLLABLE

ROLLER INSECT SCREEN

Retenedor / Retainer (SLOW C42 - SLOW C33)

Retenedor hidráulico sin embrague, suaviza la recogida del tejido.

Hydraulic retainer without clutch, softens tissue collection.

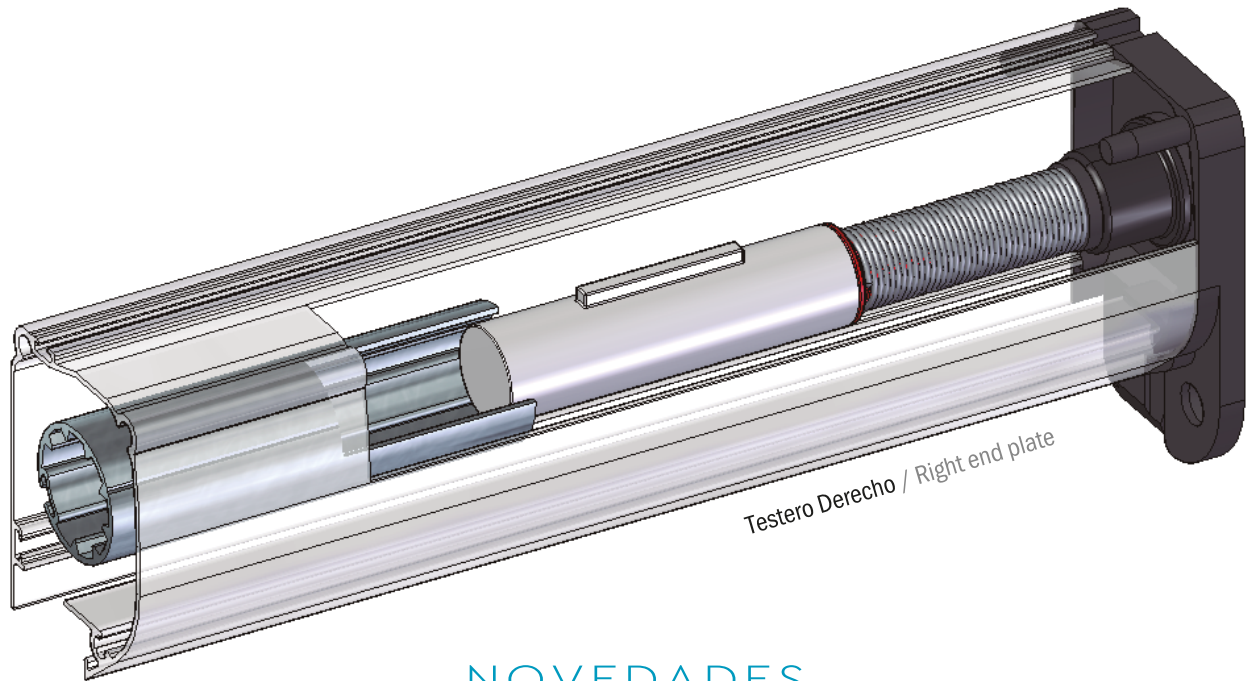

NOVEDADES
NEWS



Dos medidas: Para tubo normal (42) y para tubo pequeño (33).

Two sizes: for normal tube (42) and for small tube (33).



MOSQUITERA ENROLLABLE

ROLLER INSECT SCREEN

Retenedor / Retainer (SLOW C42)

Retenedor hidráulico sin embrague, suaviza la recogida del tejido.
Hydraulic retainer without clutch, softens tissue collection.

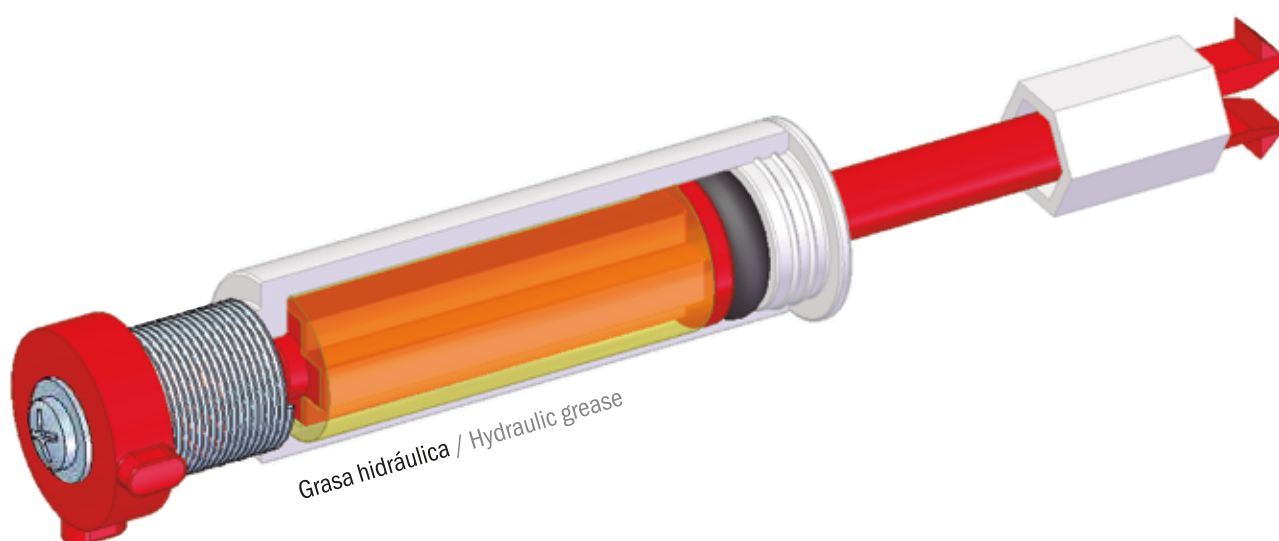
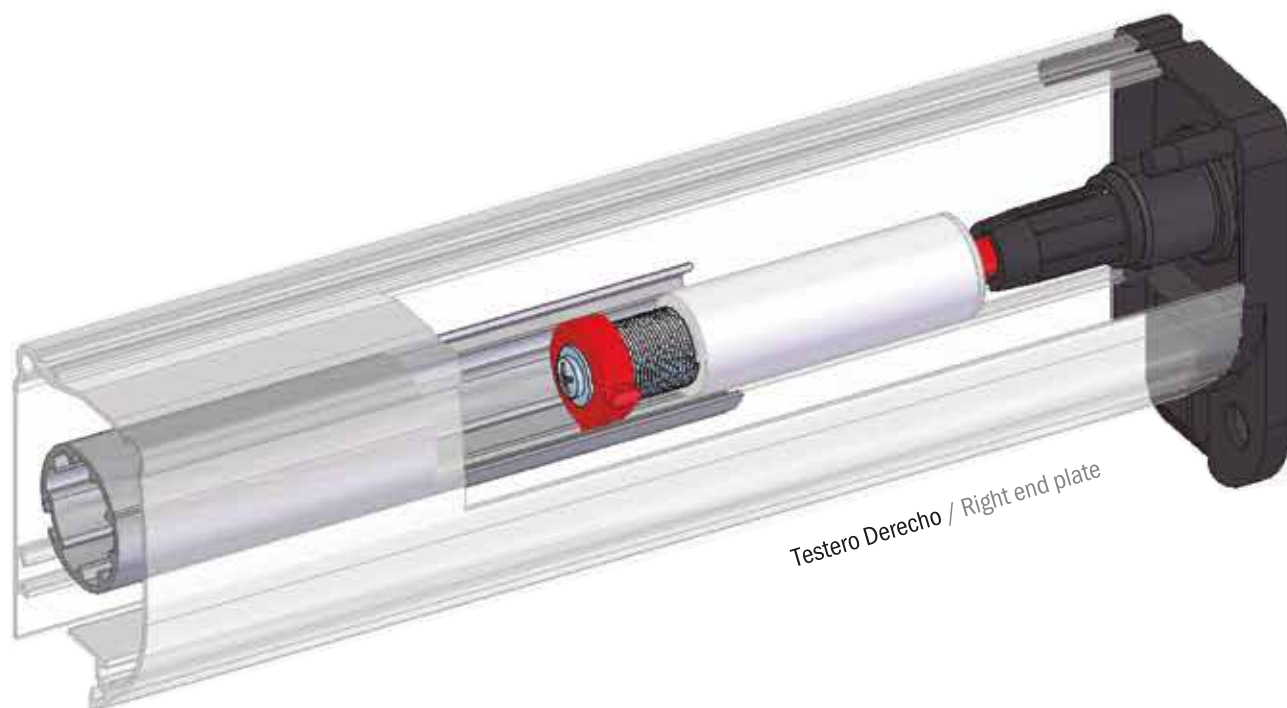

MOSQUITERA ENROLLABLE

ROLLER INSECT SCREEN

colores / colors



Accesorios mosquitera horizontal / Horizontal insect screen accessories

MANETA RECTA

STRAIGHT HANDLE



*Opcional

MANETA OVAL

OVAL HANDLE



*Opcional

MANETA CURVA

CURVED HANDLE



*Opcional

FRENO OCULTO

HIDDEN BRAKE



FRENO TUERCA

NUT BRAKE



FRENO SETA

MUSHROOM BRAKE



AUP UNIVERSAL

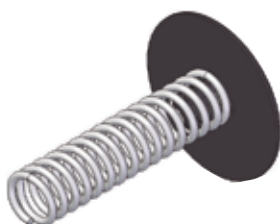

*Opcional

BUSCA TORNILLOS

SCREW TOOL

■ color negro
■ black color

caja / pack

200 u.

SLOW CON EMBRAGUE

SLOW WITH CLUTCH

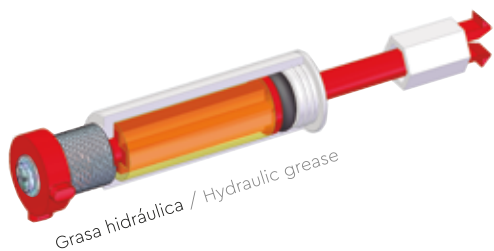

Grasa hidráulica / Hydraulic grease

SLOW 42 SIN EMBRAGUE

SLOW 42 NORMAL

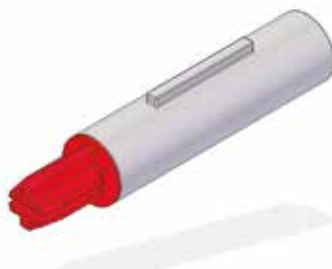

SLOW 33 SIN EMBRAGUE

SLOW 33 SMALL



MOSQUITERA ENROLLABLE ROLLER INSECT SCREEN

colores / colors

caja / pack



25 u.

Kit mosquitera lateral con cadena P42 / Lateral insect screen kit with P42 chain

Incluye:

Testero izq con muelle

Testero dch

2 Casquillos

2 Tapones poste móvil

3 Clips metálicos

8 Tacos y 10 tornillos

Cadena

Medidas cadena 120/170

Guía superior 130/180

Perfil terminal 230

Perfil cierre 230

Perfil suelo 130/180



Sin barreras
Without barriers



NOVEDADES
NEWS

Lateral con cadena
al menor coste
en el menor tiempo.

Lateral insect screen
with chain.
Cheaper and faster to install.

Includes:

Left box endacap with spring

Right box endacap

2 Spin caps

2 mobile post endcaps

3 metal clips

8 plugs and 10 screws

Chain

Chain measures 120/170

Upper guide 130/180

Terminal Profile 230

230 closing profile

130/180 floor profile

Novedad en el mercado, mosquitera enrollable lateral con cadena inferior. Por fin una mosquitera lateral compatible con cajones de 42 sin guía inferior que no obstaculiza el paso, perfecta para puertas.

Novelty in the market, lateral roller insect screen with bottom chain. Finally a lateral insect screen compatible with 42 boxes. Without bottom guide that does not hinder the passage, perfect for doors.

MOSQUITERA ENROLLABLE

ROLLER INSECT SCREEN

colores / colors

caja / pack



25 u.

Kit mosquitera lateral 1 hoja / Lateral insect screen kit 1 panel

Incluye:

Testeros izq y dch

Muelle, funda y pivote

Muelle inverso, funda y pivote

Set manetas fija y abatible
con tornillos fijación

Soporte, roldana guía y espárrago

2 Casquillos

2 Tapón terminal

3 Clips metálicos

8 Tacos y 10 tornillos

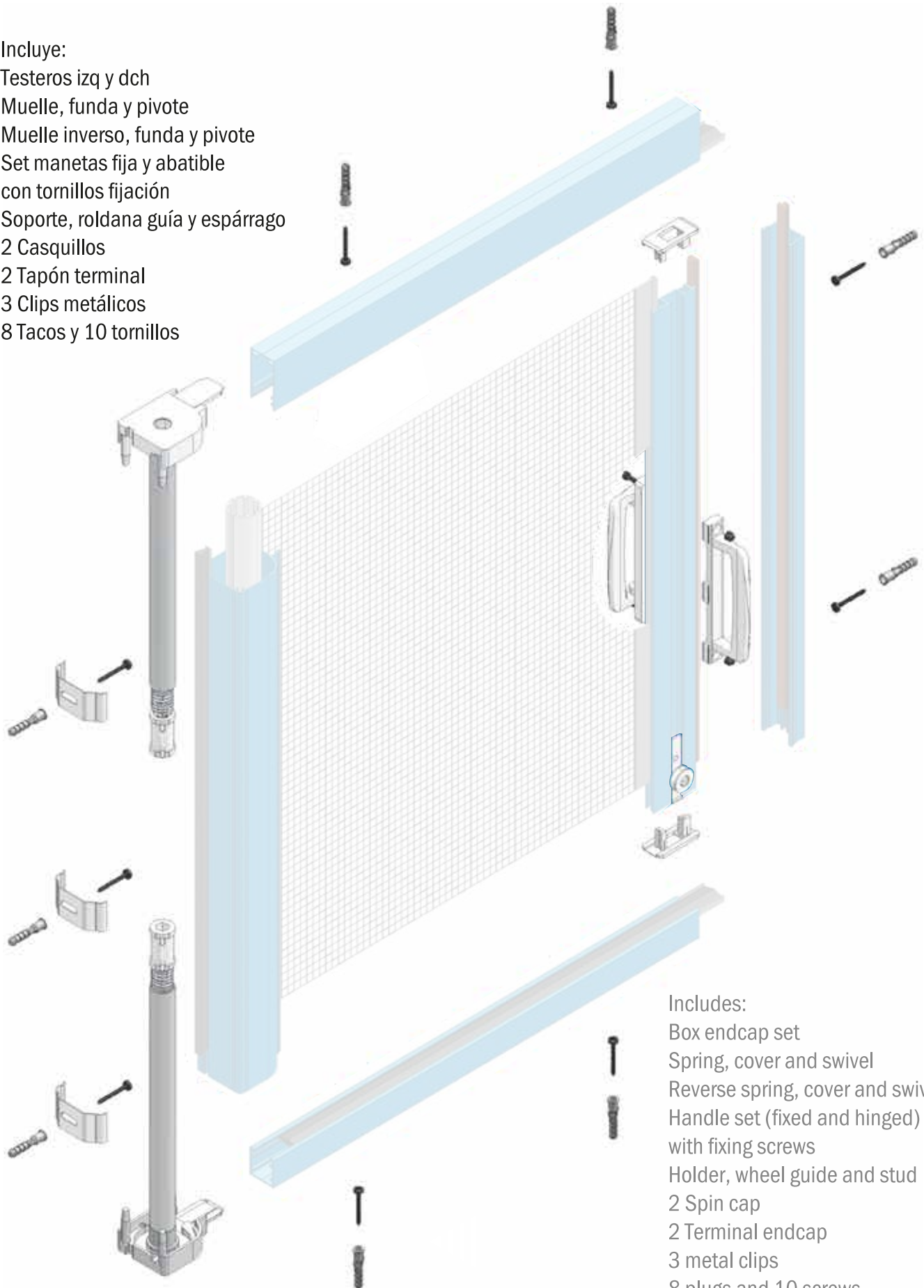

Includes:

Box endcap set

Spring, cover and swivel

Reverse spring, cover and swivel

Handle set (fixed and hinged)
with fixing screws

Holder, wheel guide and stud

2 Spin cap

2 Terminal endcap

3 metal clips

8 plugs and 10 screws

MOSQUITERA ENROLLABLE

ROLLER INSECT SCREEN

colores / colors

caja / pack



12 u.

Kit mosquitera lateral 2 hoja / Lateral insect screen kit 2 panels

Incluye:

- Dos juegos testeros izq y dch
- 2 Muelles con funda y pivote
- 2 Muelles inverso con funda y pivote
- Set manetas fija y abatible con tornillos fijación
- Soporte, roldana guía y espárrago
- Porta muelles y 4 muelles con espárrago
- 4 Casquillos
- 4 Tapón terminal
- 6 Clips metálicos
- 2 varilla PVC con pomo
- 2 lengüeta unión con espárrago
- 2 bolsas: 8 Tacos y 10 tornillos

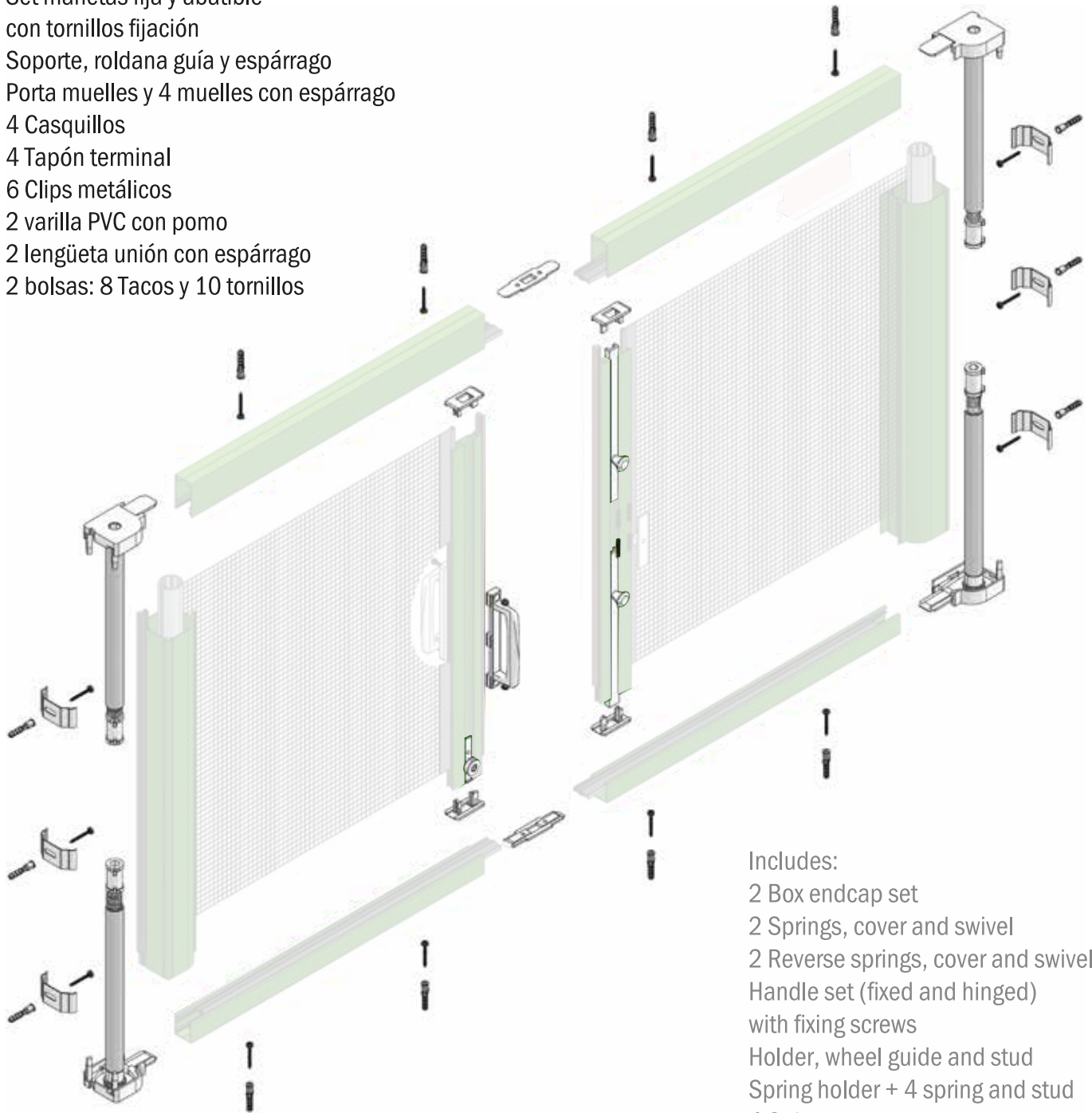

Includes:

- 2 Box endcap set
- 2 Springs, cover and swivel
- 2 Reverse springs, cover and swivel
- Handle set (fixed and hinged) with fixing screws
- Holder, wheel guide and stud
- Spring holder + 4 spring and stud
- 4 Spin caps
- 4 Terminal endcap
- 6 metal clips
- 2 PVC bar with handle
- 2 Flat union piece
- 2 packs: 8 plugs and 10 screws

MOSQUITERA ENROLLABLE

ROLLER INSECT SCREEN

Cabezales compatibles mosquitera lateral

Lateral insect screen compatible heads

CAJÓN
BOX 46

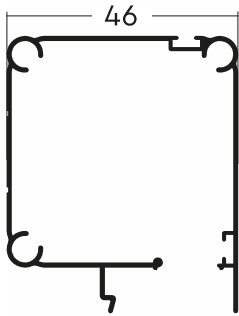

C46

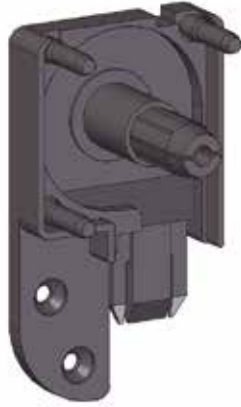

CAJÓN
BOX P42

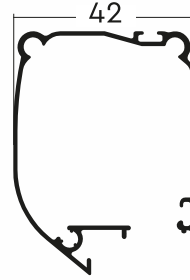

P44

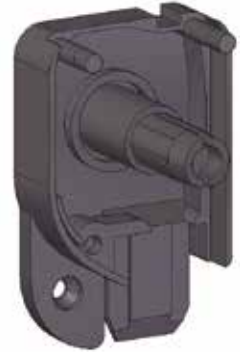

CAJÓN
BOX P42

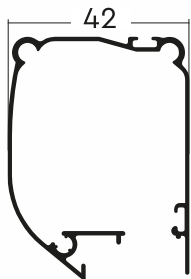

P42



CAJÓN
BOX R42

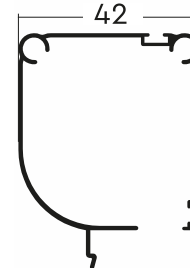

R42

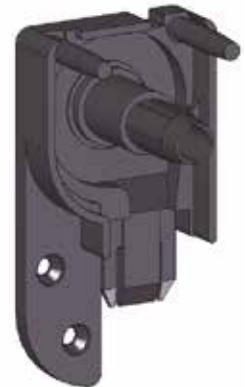

CAJÓN
BOX 33

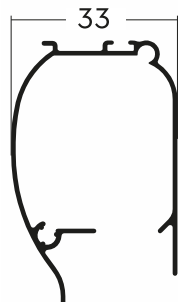

R33

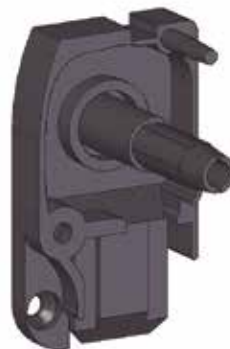

MOSQUITERA ENROLLABLE

ROLLER INSECT SCREEN

Accesorios mosquitera lateral / *Lateral insect screen accessories*

MANETA ABATIBLE

HINGED HANDLE



MANETA FIJA

FIXED HANDLE



CLIP METÁLICO

METALLIC CLIP



PORTA MUELLES

SPRING HOLDER



VARILLA PVC Y POMO

PVC BAR WITH HANDLE



SOPORTE Y ROLDANA

WHEEL GUIDE HOLDER



TAPÓN TERMINAL

TERMINAL ENDCAP



LENGÜETA UNIÓN

FLAT UNION PIECE



MOSQUITERA CORREDERA

SLIDING INSECT SCREEN

colores / colors



caja / pack

75 u.

Kit (curva y recta) / kit (curved and straight)

Incluye:

2 Escuadras superiores

2 Escuadras inferiores con rodamientos

Includes:

2 upper corners.

2 lower corners with bearings.

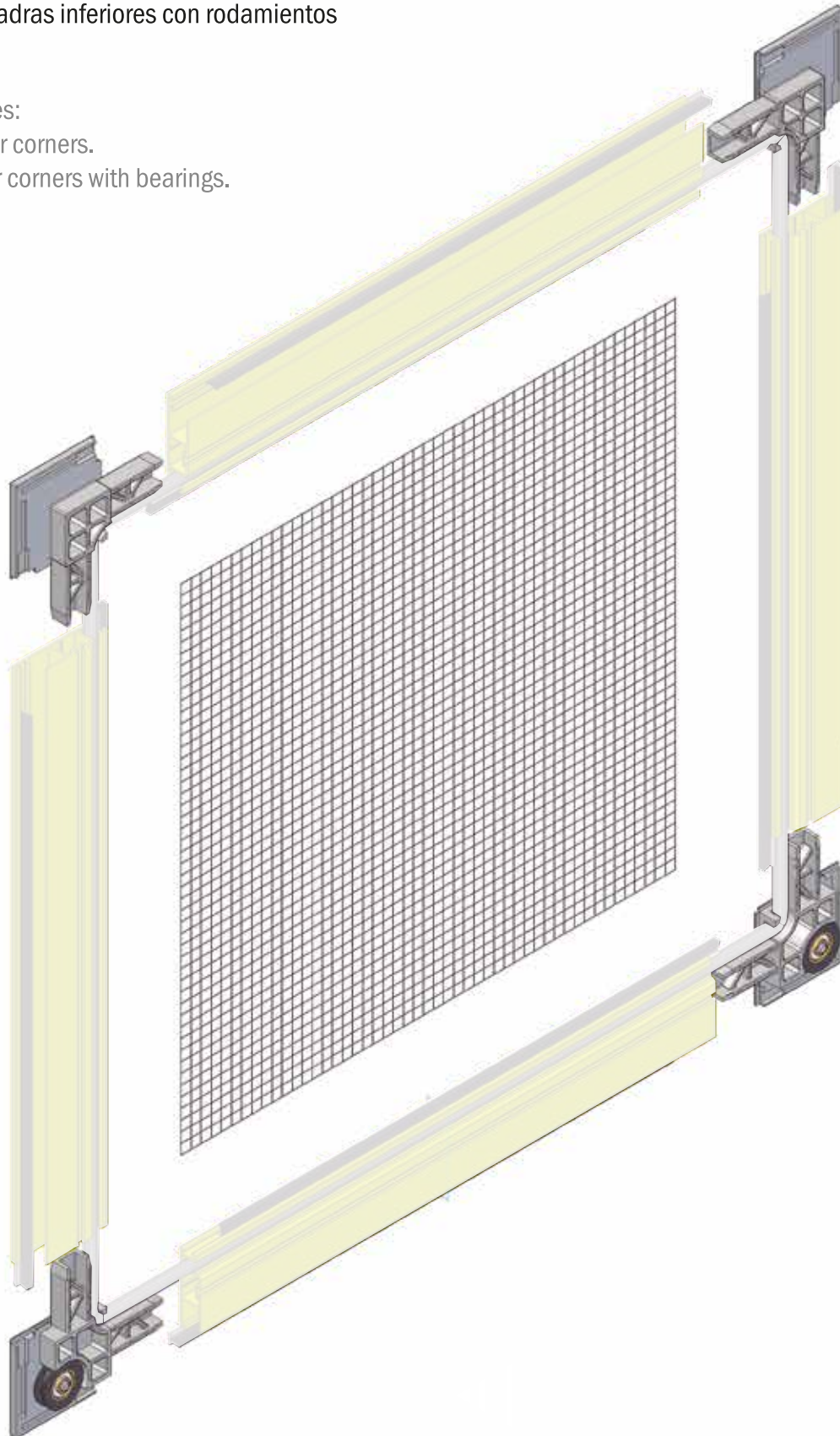

CURVA 50

CURVE 50

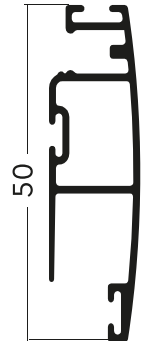

CURVA 48

CURVE 48

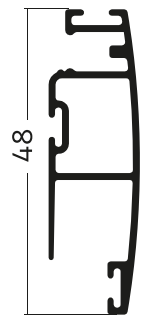

RECTA

STRAIGHT

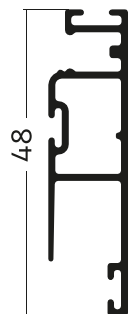

MOSQUITERA CORREDERA

SLIDING INSECT SCREEN

Accesorios (curva y recta) / Accessories (curved and straight)

ESCUADRA CURVA SUPERIOR

TOP CURVED CORNER



ESCUADRA CURVA INFERIOR CON RODAMIENTO

DOWN CURVED CORNER

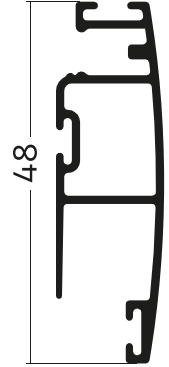
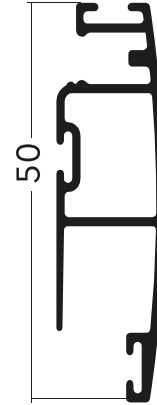
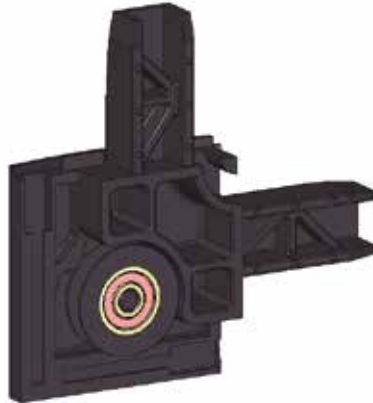

ESCUADRA RECTA SUPERIOR

TOP STRAIGHT CORNER



ESCUADRA RECTA INFERIOR CON RODAMIENTO

DOWN STRAIGHT CORNER

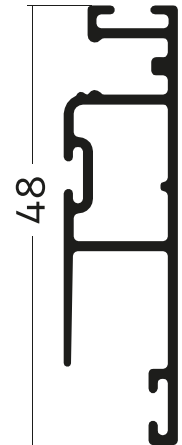
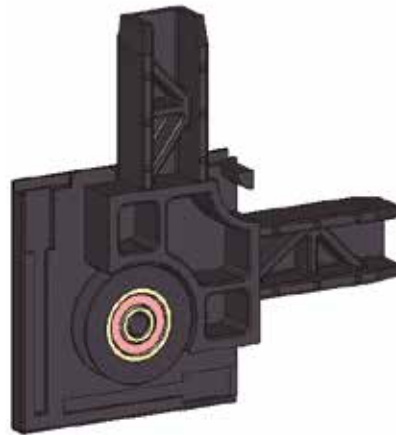

SOPORTE TRAVESAÑO CURVO CON ESPÁRAGO

CURVED TRAVERSE HOLDER



SOPORTE TRAVESAÑO RECTO CON ESPÁRAGO

STRAIGHT TRAVERSE HOLDER

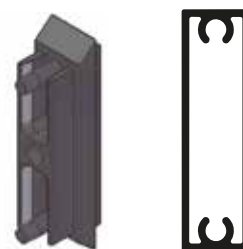

MOSQUITERA CORREDERA

SLIDING INSECT SCREEN

colores / colors



caja / pack

75 u.

Kit (regulable) / Kit (adjustable)

Incluye:

- 2 Escuadras superiores con muelle y roldana
- 2 Escuadras inferiores con rodamientos y regulado por tuerca

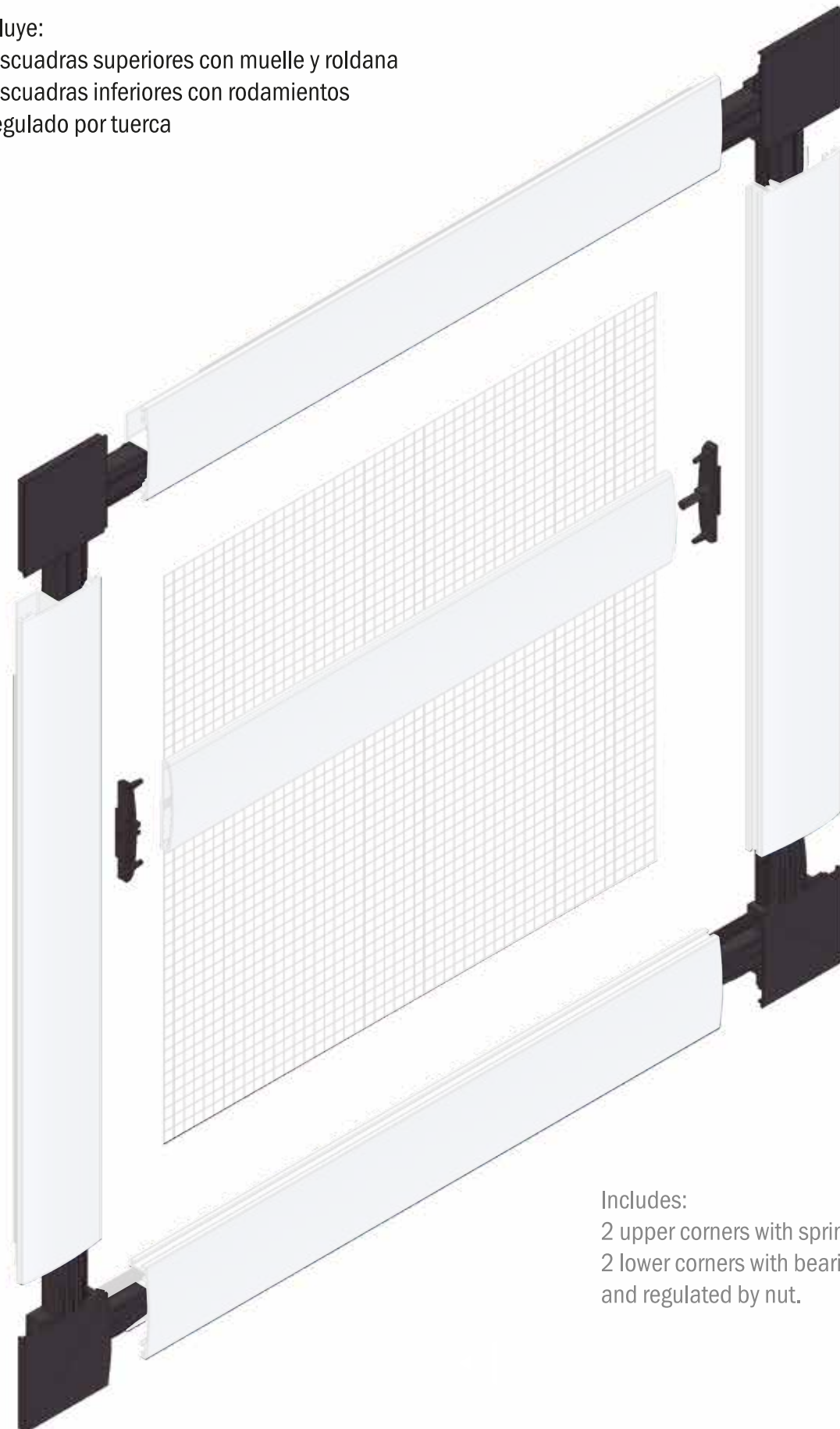

CURVA
CURVE

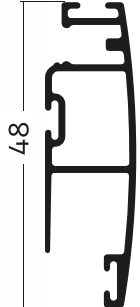

Includes:

- 2 upper corners with spring and wheel guide.
- 2 lower corners with bearings and regulated by nut.

MOSQUITERA CORREDERA

SLIDING INSECT SCREEN

Accesorios (regulable) / Accessories (adjustable)

ESCUADRA SUPERIOR ANTIDESCARRILAMIENTO

TOP CORNER NO DERAIL

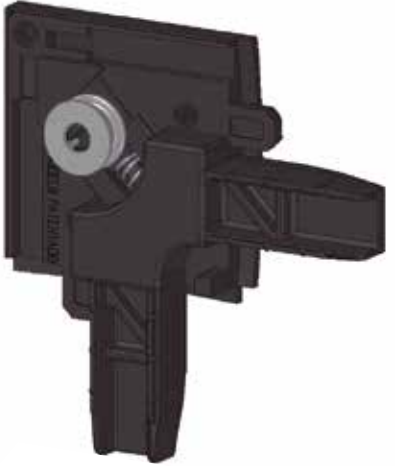

Vista trasera / Back side



Vista frontal sin tapa / Front side without cover



Tapa / Cover

ESCUADRA INFERIOR REGULABLE (4MM.)

DOWN CONER ADJUSTABLE (4MM.)



Vista trasera / Back side



Vista frontal sin tapa / Front side without cover



Tapa / Cover

SOPORTE TRAVESERO CURVO CON ESPARRAGO

CURVED TRAVERSE HOLDER



SOPORTE TRAVESAÑO RECTO CON ESPÁRAGO

STRAIGHT TRAVERSE HOLDER

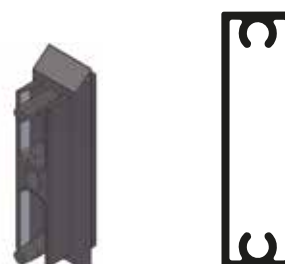

MOSQUITERA CORREDERA

SLIDING INSECT SCREEN

Kit (Mini 35) / Kit (Mini 35)

Incluye:

2 Escuadras superiores (Mini 35)

2 Escuadras inferiores (Mini 35)

Includes:

2 Upper corners (Mini 35)

2 Lower corners (Mini 35)

MINI 35

MINI 35

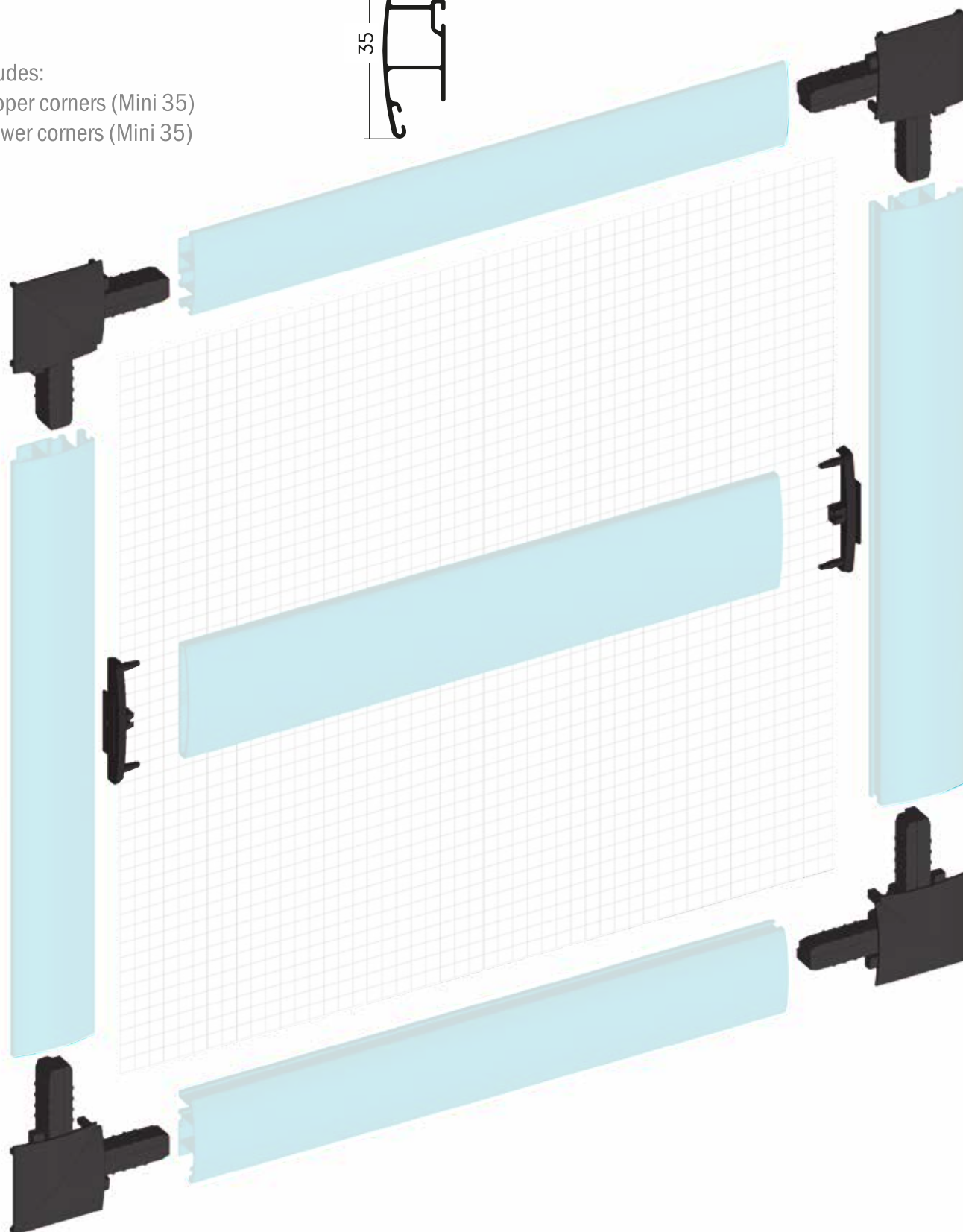
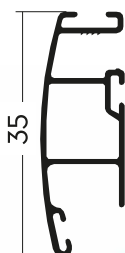

MOSQUITERA FIJA

FIXED INSECT SCREEN

colores / colors



caja / pack

75 u.

Kit

Incluye:

4 Escuadras (fija)

Includes:

2 Corners (fixed)

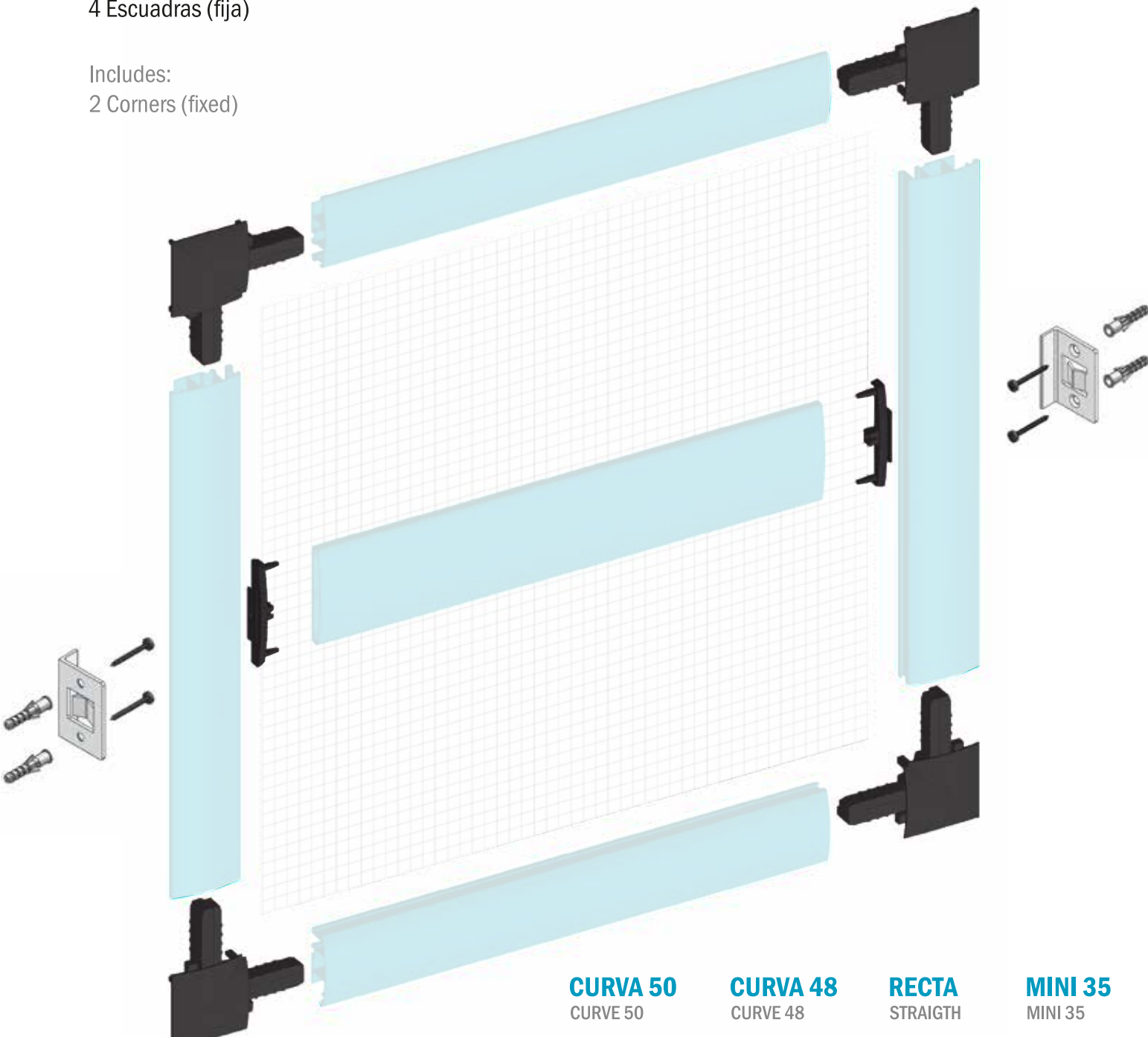

*Opcional

CLIP SUJECCIÓN
MOSQUITERA FIJA

FIXED CLIP



colores: negro / blanco
colors: black / white

CURVA 50
CURVE 50

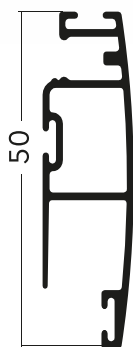

CURVA 48
CURVE 48

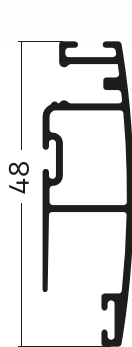

RECTA
STRAIGHT

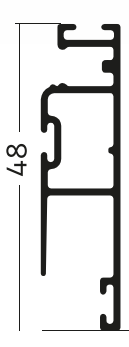

MINI 35
MINI 35



ACCESORIOS MOSQUITERA

INSECT SCREEN ACCESSORIES

CONTADOR TENSA MUELLES

SPRING TENSIONER WITH LAP COUNTER



RODILLO METE GOMA

ROLLER TO COUPLE RUBBER



ESCUADRA 60X20

60X20 BRACKET

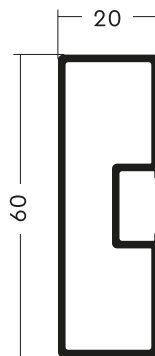

RODAMIENTO PARA EJE 5 MM.

BEARING FOR 5MM. AXIS

Ø 24 mm

caja / pack
2.000 u.

Ø 18,5 mm

caja / pack
4.000 u.

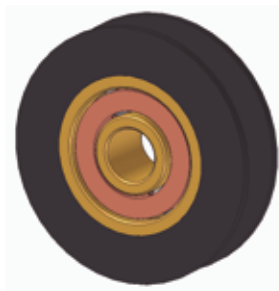

Diámetro exterior (mm)
External diameter (mm)

18.5	Stock
19	Bajo pedido / On request
19.5	Bajo pedido / On request
20	Bajo pedido / On request
20.5	Bajo pedido / On request
21	Bajo pedido / On request
21.5	Bajo pedido / On request
22	Bajo pedido / On request
22.5	Bajo pedido / On request
24	Stock

¿QUE PODEMOS HACER POR TI?

WHAT CAN WE DO FOR YOU?

- Asesoramiento técnico / Technical advice.
- Desarrollo de productos / Product development.
- Personalización de producto / Product customization.

CONSÚLTANOS

CONTACT US FOR MORE INFORMATION

TELÉFONO / PHONE: (+34) 962 78 23 20
Técnicas Agroplastic (+34) 629 782 816

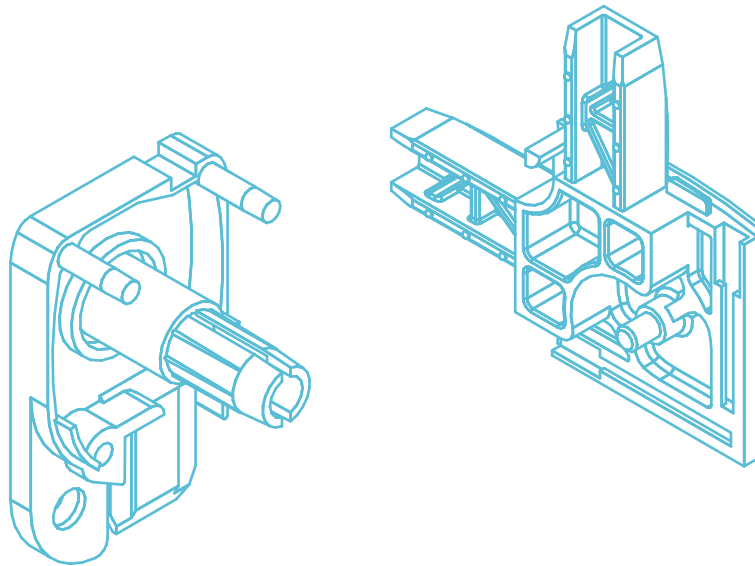

Grupo Sanz

Grupo Sanz

www.agroplastic.com



Agroplastic

GRUPO SANZ